

Mansfield[®] johnny valve[™]

**TOILET REFILL VALVE
with adjustable integral float
and hydraulically balanced shutoff.**

Here is Mansfield Sanitary's answer for an easy-to-install, economical and dependable way to replace worn out refill valves.

Johnny Valve is made of Celcon*, polyethylene and polypropylene to be corrosion resistant. Designed and manufactured by Mansfield for total quality control. The Johnny Valve built-in float system provides complete water level adjustment and can be set for the exact balance of efficient flushing and minimum water usage. Its sure seal means no leaks, plus efficient operation at high or low water pressures.

Full-flow design fills the tank faster than ordinary refill valves or ballcocks, and Johnny Valve fits most toilet tanks—including the new 3½ gallon water conservation models. Like all Mansfield valves, the 05 is individually water tested for reliability.

Use these specifications to order

Order No.	Description	Approx. Weight Lbs.
05	Johnny Valve toilet refill valve, complete with integral float, vinyl refill tube, locknut and coupling nut, coupling nut washer, and shank gasket.	

Available in attractive point-of-purchase individual box or pegboard skin packaging. Packed 25 per master carton.

13 lbs.

Specify individual boxed or skin packed when ordering.



*Celcon is the registered trademark of Celanese Corp.

johnny valve™

05 TOILET REFILL VALVE

components and parts list

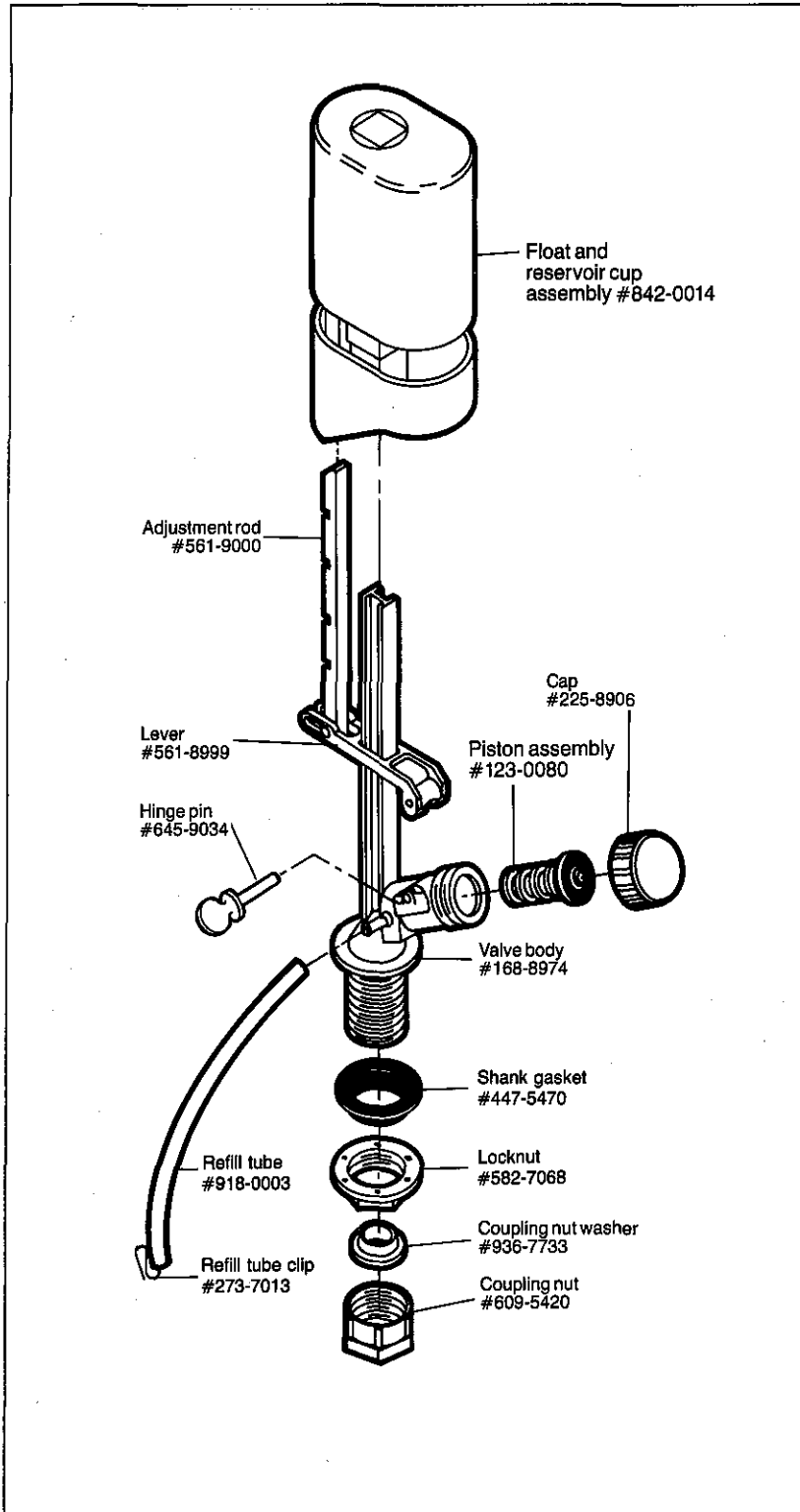

05 TOILET REFILL VALVE SERVICE PAK NO. 630-0022

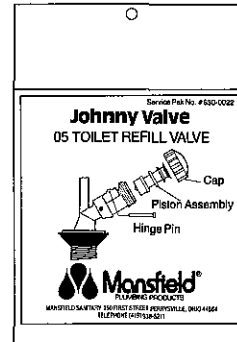

Service Pak includes:
Piston assembly
Pin and cap

Slip Joint Connection

5/8"

West Coast

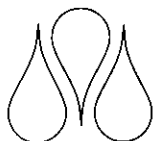
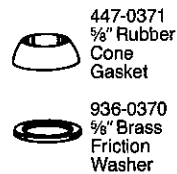

Mansfield®
PLUMBING PRODUCTS

MANSFIELD SANITARY/150 FIRST STREET/PERRYSVILLE, OHIO 44864/TELEPHONE (419) 938-5211





A simple new way to increase replacement sales.

Now, from Mansfield Sanitary, comes a new replacement toilet refill valve that gives you what others can't: the Mansfield name and experience.

The Johnny Valve™ offers a choice of packaging to reinforce your merchandising approach. It fits most tanks, including the 3½ gallon watersaver models. It saves water by replacing leaky, inefficient ballcocks and floats. It's totally adjustable, so it can be set for the

most effective water usage. It's corrosion-resistant for long-life dependability. It carries the GOOD HOUSEKEEPING SEAL. And best of all, it's simple! Simple in concept. Simple to install. Simple for you to handle and sell.

The new Johnny Valve. Available in individual boxes or shrink paks. Ask your Mansfield representative.

Mansfield
 PLUMBING PRODUCTS

 A DIVISION OF
 INTERPACE

MANSFIELD SANITARY/150 FIRST STREET/PERRYVILLE, OHIO 44864 / TELEPHONE (419) 938-5211

Mansfield® Watersaver flush valve

The outstanding Mansfield 209—proved in millions of toilets since 1967—combines water-saving efficiency with non-corrosive, long-life dependability. Because the Watersaver is controlled directly through the tank lever, unique partial flushing can be allowed, saving water. This design also makes instant shut-off possible in case of bowl overflow. Totally formed of MARBON "T" A.B.S. plastic, the Watersaver is unaffected by rust, corrosion or electrolytic action. It seats and seals tight everytime (another watersaving *plus*). Its tank lever holder won't loosen or slip—can't bind or stick—eliminates handle jiggling. It has only one moving part, so it's trouble-free. And thanks to its offset design, the Mansfield 209 fits *most* tanks. For the best of water-saving efficiency, positive operation and long-life dependability, the Mansfield 209 Watersaver is a proven

Use these specifications to order

Order No.	Description	Approx. Weight
209	Watersaver Flush Valve with tank-to-bowl gasket and locknut, 10" refill tube assembly and tank lever. Individually boxed. Packed 10 per carton.	13 lbs.
208	Watersaver Flush Valve, same as 209 except fits only Mansfield china tanks. Individually boxed. Packed 10 per carton.	13 lbs.

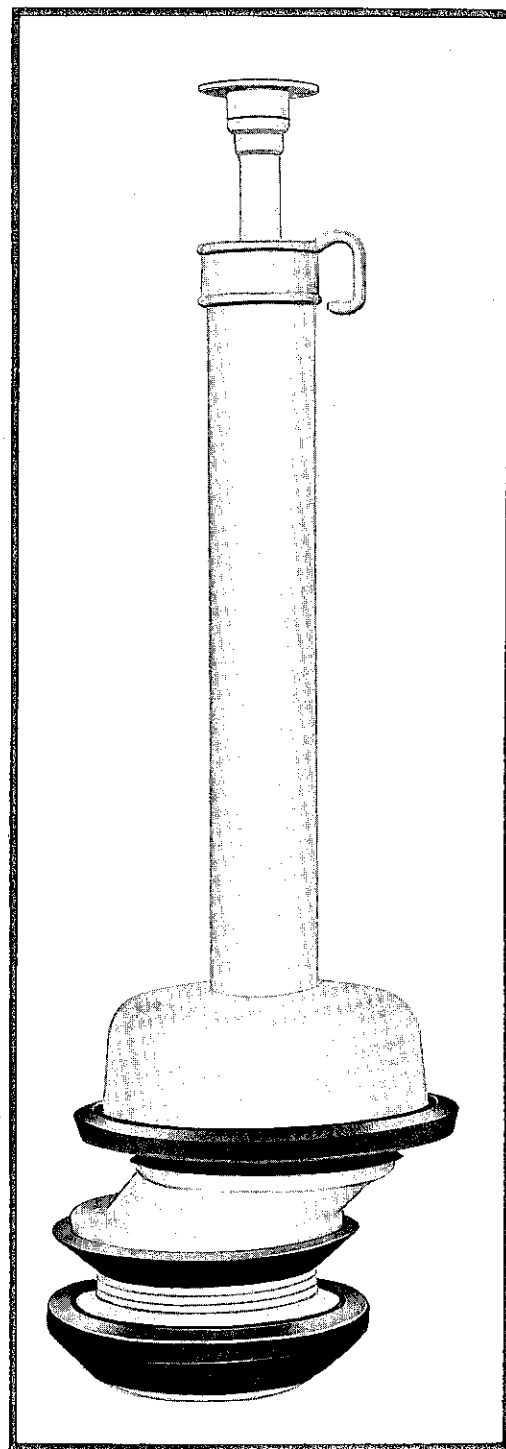

Patent Nos. 2,945,239 3,172,129 3,267,491 3,890,652



Mansfield®
PLUMBING PRODUCTS

Watersaver 209 flush valve

components and parts list

When ordering, refer to part number and description

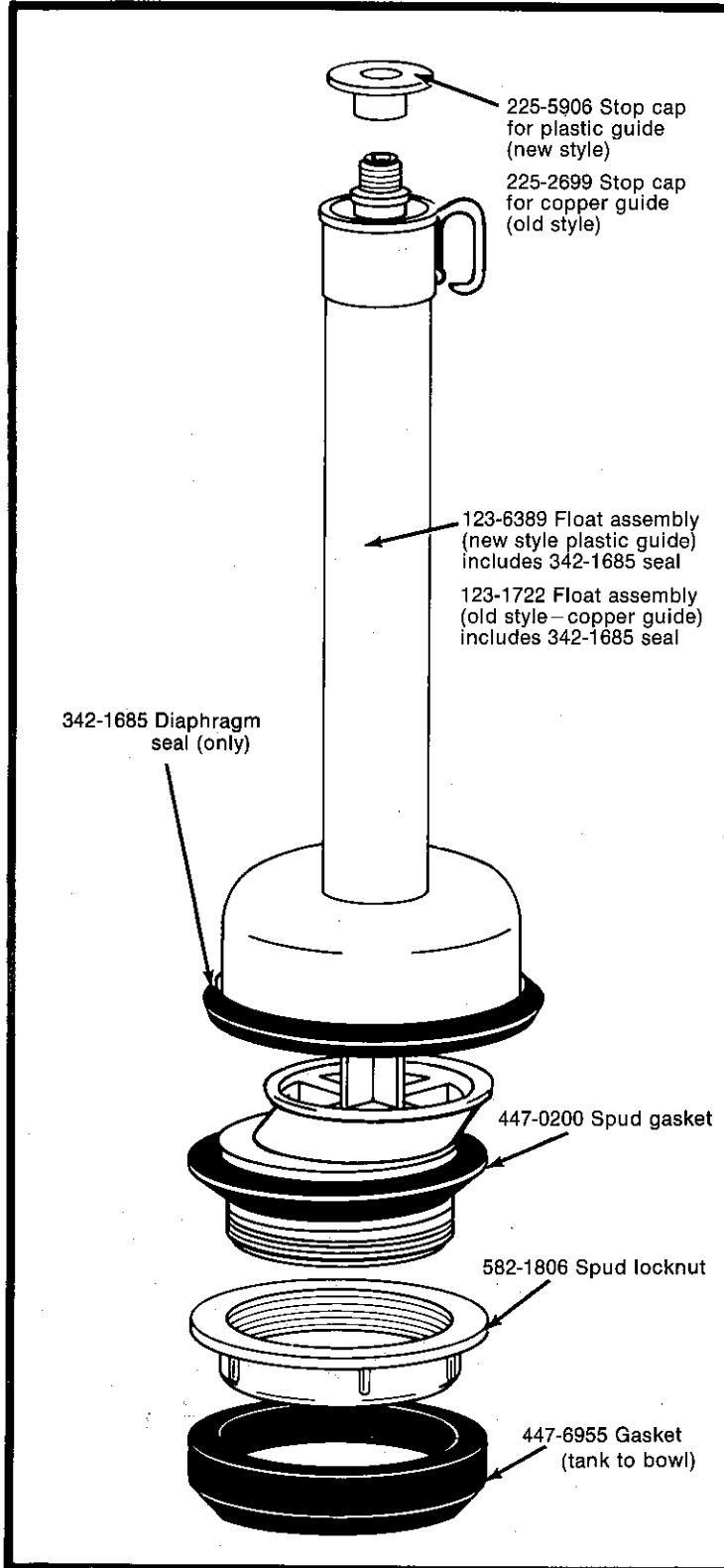

WATERSAVER FLUSH VALVE SERVICE PAK No. 4837

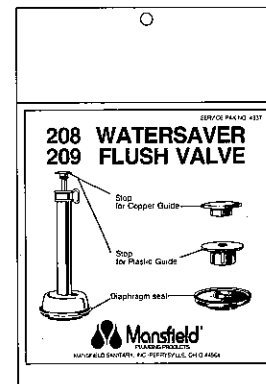

Service Pak includes:

- Diaphragm seal
- Stop cap (old style)
- Stop cap (new style)

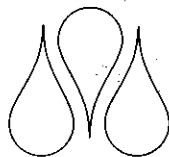

Mansfield[®]
PLUMBING PRODUCTS

heavy-duty 03 ballcock

brass construction, adjustable

The 03 is the heavy-duty ballcock in the Mansfield line. This rugged model offers trouble-free dependability as its prime benefit – and famous Mansfield efficiency. For reliability, the 03 offers a longlife nylon valve seat; smooth-finish, heavy red brass casting; and seamless copper riser pipe. For quiet, Mansfield has designed the 03 water passage with a by-pass – eliminating whines, squeals and rattles. For efficiency, the 03 features compound lever action that gives positive opening and closing at all pressures. Positive action brass plunger with split leather washer to prevent squirting; easy water flow adjustment; and smooth, flat neoprene seating (no screw in the plunger). Rugged all through, the Mansfield 03 ballcock provides heavy-duty service, and no call-back dependability you can rely on.

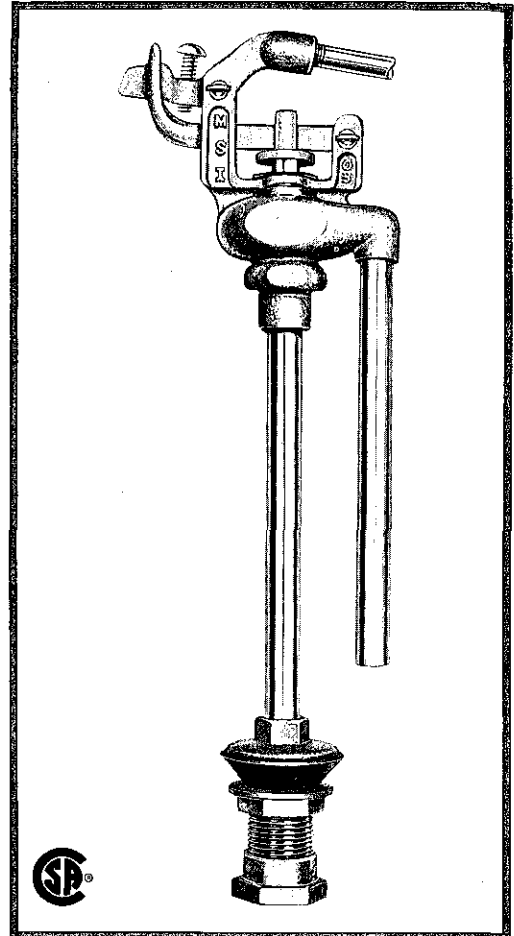

Use these specifications to order

Order No.	Description	Approx. Weight Lbs.
03	Ballcock, complete with 8" brass float rod and 10" vinyl refill tube, brass locknut and coupling nut, coupling nut washer and shank gasket. Individually boxed, 24 boxes to a carton.	38

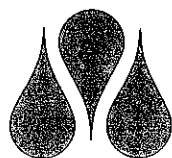
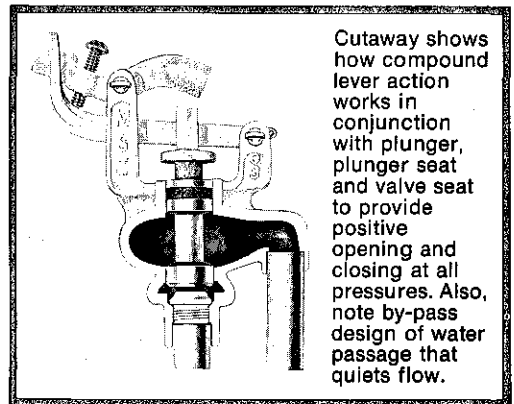

Mansfield[®]
PLUMBING PRODUCTS

03 ballcock

components and parts list

When ordering, refer to part number and description

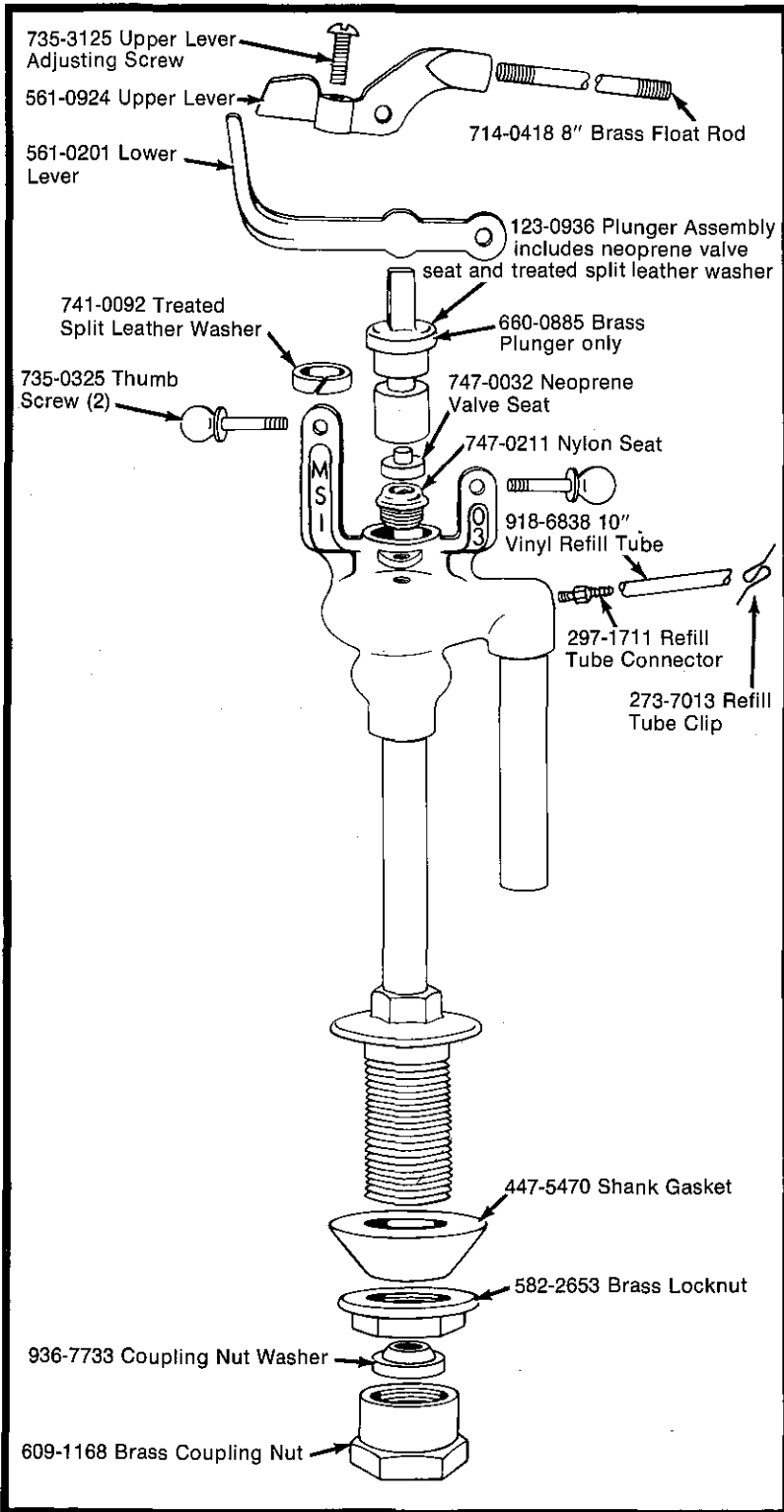

No. 422 Shank Extender



Extends all regular ballcock shanks to 2 $\frac{3}{4}$ " length. Eliminates need for repair shank ballcocks.

Slip Joint Connection

$\frac{5}{8}$ "

West Coast

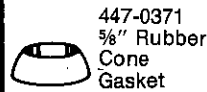

447-0371
 5/8" Rubber
 Cone
 Gasket

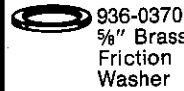

936-0370
 5/8" Brass
 Friction
 Washer



447-0281
 1/2" Rubber
 Cone Gasket



936-0065
 1/2" Brass
 Friction
 Washer



609-1165
 Brass Coupling
 Nut, 1/2" Inlet
 Hole

03-09-XQ16 BALLCOCK SERVICE PAK No. 7066

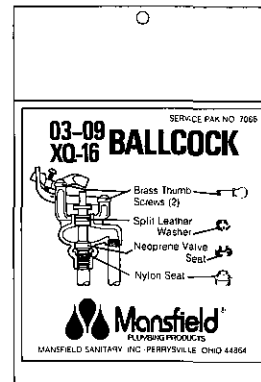

Service Pak includes:

Thumb screw (2) • Nylon seat
 Neoprene valve seat • Split washer

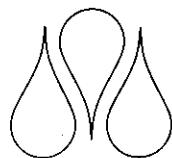

Mansfield[®]
 PLUMBING PRODUCTS

code approved, anti-siphon 07 ballcock

deluxe, brass construction, completely adjustable

The 07 offers just what you'd expect from one of Mansfield's finest. It is remarkably efficient, dependable, quiet—and lets you offer features found in no other ballcock. Thanks to its specially designed silencer and bottom outlet, the 07 operates almost noiselessly. Its quick, snap-action shutoff eliminates whine and whistle; its PVC hush tube prevents chatter. The 07 is efficient, too, operating equally well at low or high pressures; with easy adjustability to control water refill for both tank and bowl. For dependability, Mansfield has designed the 07 with a seat disc of longlife Celcon.* (If servicing should be needed, all internal parts are easily accessible.) Importantly, the Mansfield 07 meets all code requirements. It is anti-siphon, preventing water from the tank being back-siphoned into the water supply. The silent 07 is Mansfield's finest anti-siphon ballcock.

Celcon* is the registered trademark of Celanese Corp.

Use these specifications to order

Order No.	Description	Approx. Weight Lbs.
07	Ballcock with 8" brass float rod, 8" vinyl refill tube, brass locknut and coupling nut, coupling nut washer and shank gasket. Individually boxed, 24 boxes to a master carton. Available in 10", 11½", 12½" and 14" lengths.	41

Mansfield 07 Meets Federal Specifications WW-P-541.

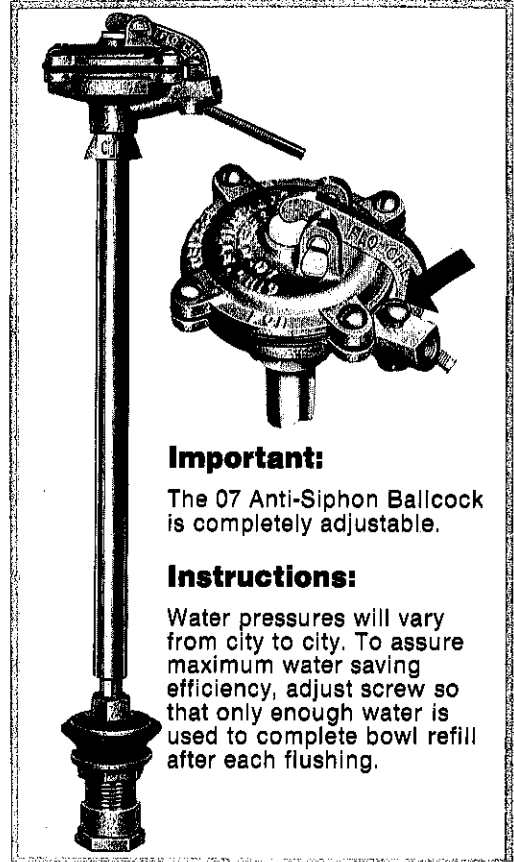

Important:

The 07 Anti-Siphon Ballcock is completely adjustable.

Instructions:

Water pressures will vary from city to city. To assure maximum water saving efficiency, adjust screw so that only enough water is used to complete bowl refill after each flushing.

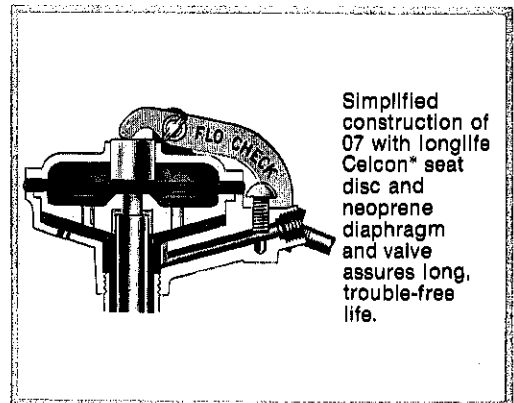

Simplified construction of 07 with longlife Celcon* seat disc and neoprene diaphragm and valve assures long, trouble-free life.

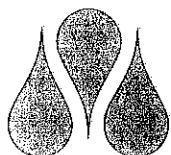

Mansfield[®]
PLUMBING PRODUCTS

07 ballcock

components and parts list
When ordering, refer to part number and description

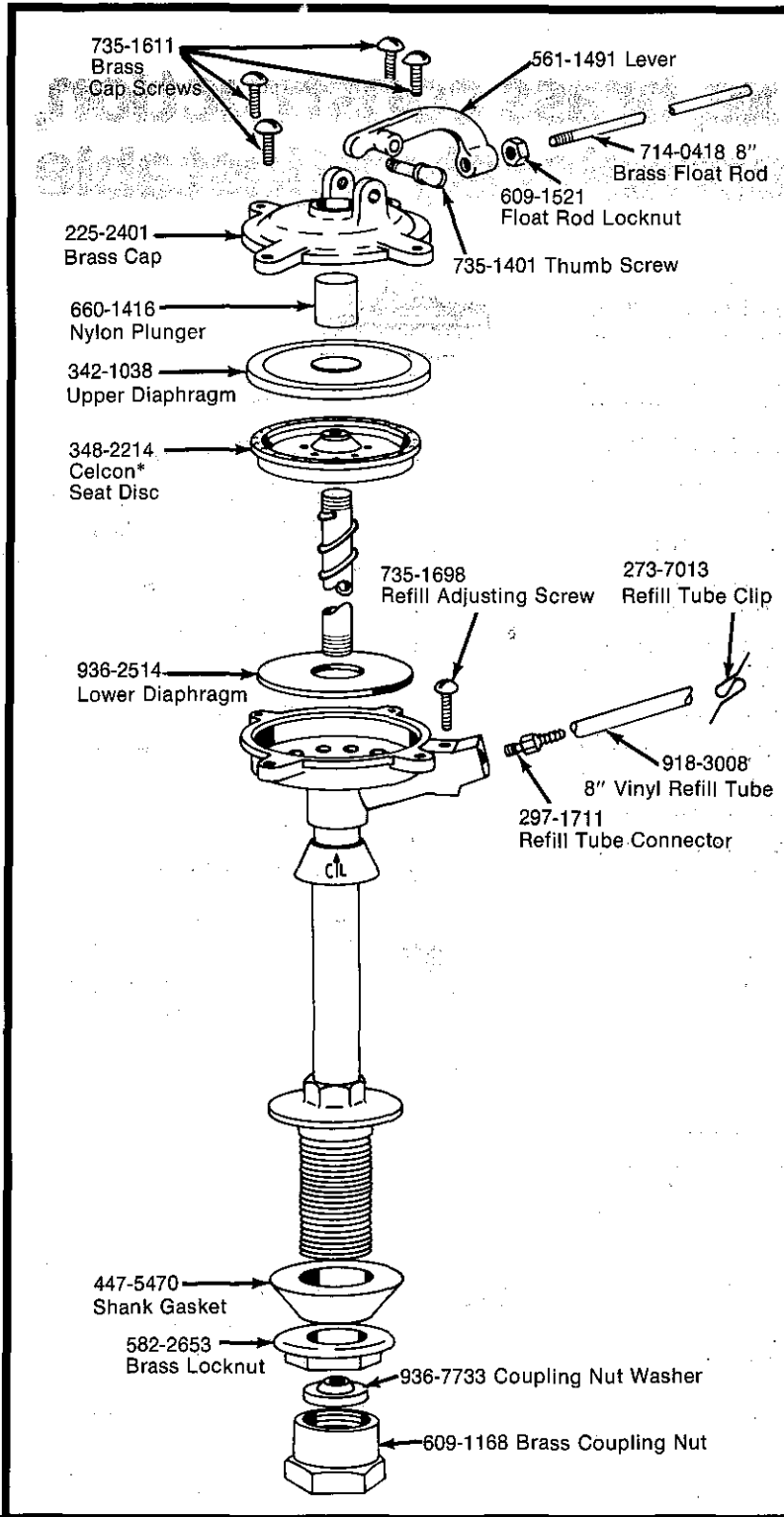

No. 422 Shank Extender



For extending all regular ballcock shanks to 2¾" length. Eliminates need for repair shank ballcocks.

Slip Joint Connection

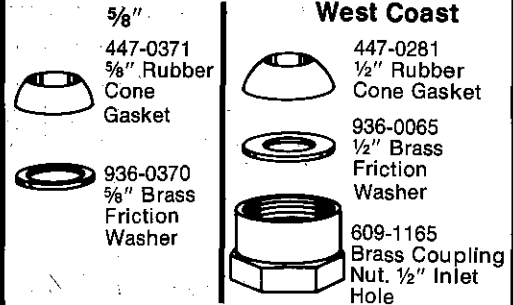

07A BALLCOCK SERVICE PAK No. 5702

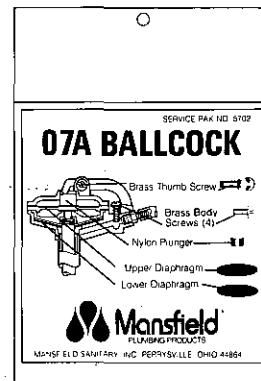

Service Pak includes:

Upper diaphragm • Lower diaphragm
Thumb screw • Nylon plunger
Body screw (4)



competitive 09 ballcock quality brass construction

The 09 is the economy ballcock, but with quality that's true Mansfield, through and through. Its features include a smooth-finish, heavy red brass casting; seamless copper riser pipe; longlife nylon valve seat; a smooth, flat-seating plunger (with no screw to interfere with the seal); split leather washer to prevent squirting; and compound lever action to assure positive opening and closing at all pressures. There's no whine, no whistle, no squeal or rattle. The 09 is precision machined to operate dependably, positively – to make it the standard as a low cost, high quality ballcock.

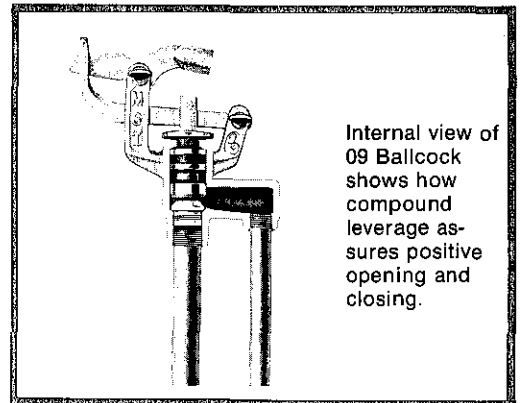
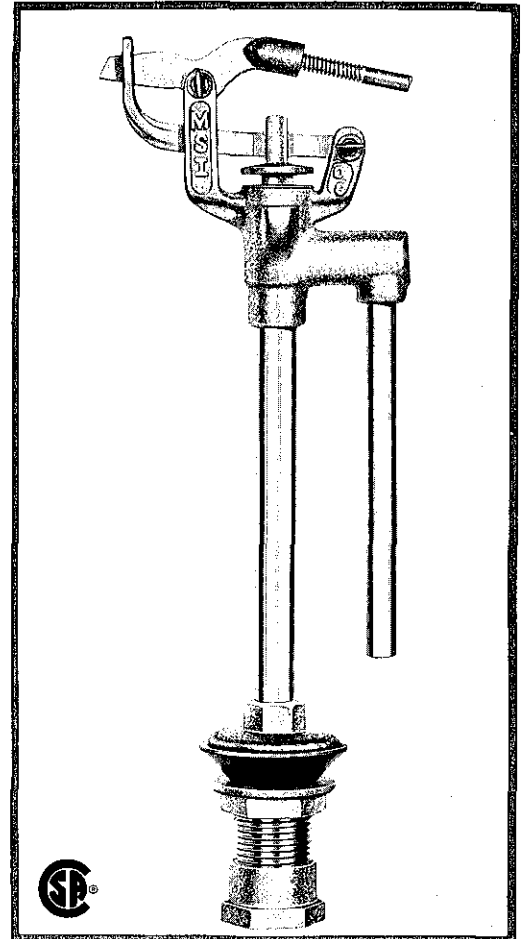

Internal view of 09 Ballcock shows how compound leverage assures positive opening and closing.

Use these specifications to order

Order No.	Description	Approx. Weight Lbs.
09	Ballcock with brass plunger, PVC hush tube, 8" brass float rod and 10" vinyl refill tube, brass locknut and coupling nut, coupling nut washer, and shank gasket.	28

Mansfield 09 Ballcocks are available in individual boxes, skin-paks, boxed 6-paks, display paks and bulk packed.

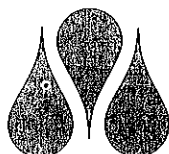

Mansfield[®]
PLUMBING PRODUCTS

09 ballcock

components and parts list

When ordering, refer to part number and description

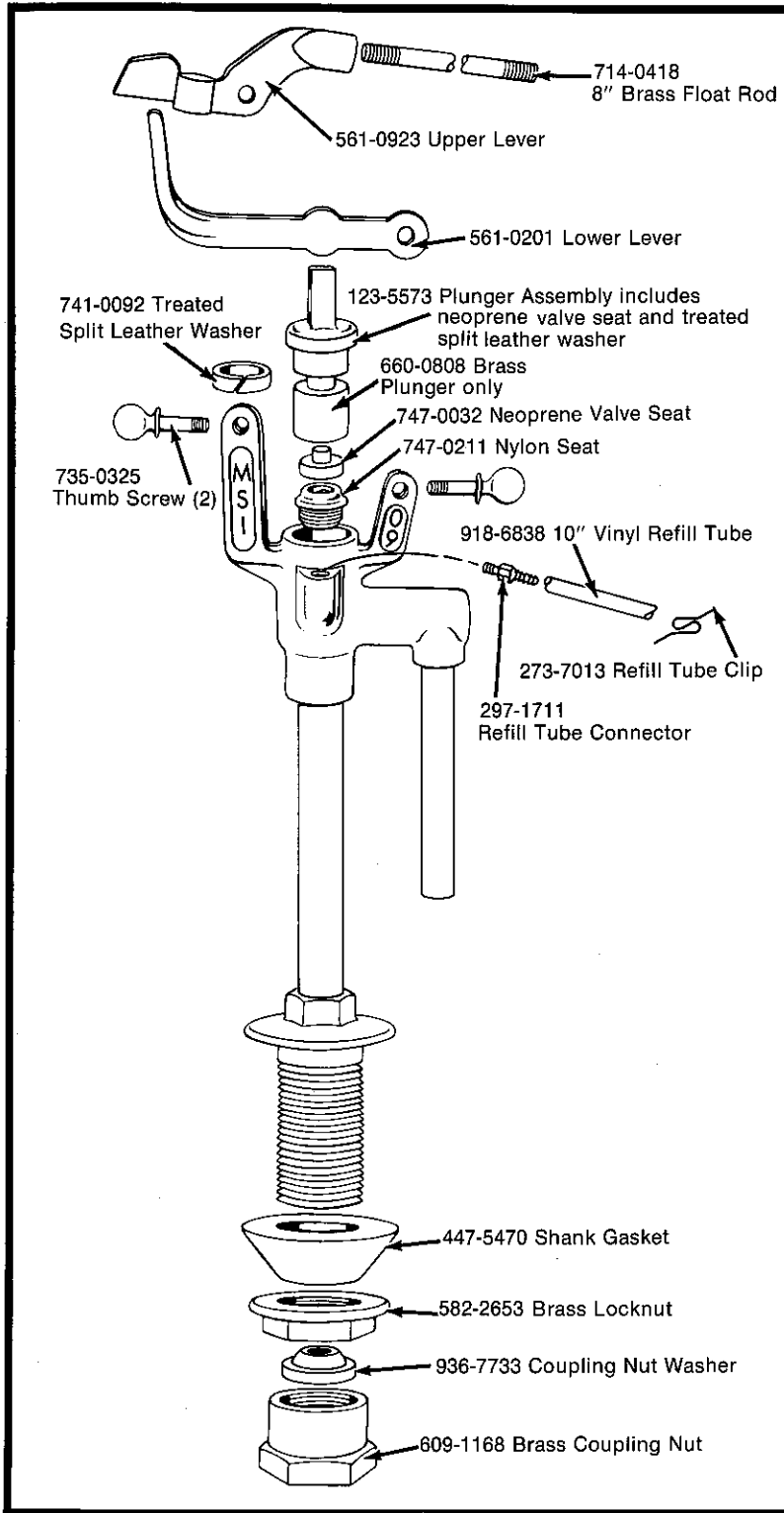

No. 422 Shank Extender

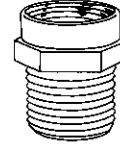

Extends all regular ballcock shanks to 2 $\frac{3}{4}$ " length. Eliminates need for repair shank ballcocks.

Slip Joint Connection

5/8"

447-0371
5/8" Rubber
Cone
Gasket



936-0370
5/8" Brass
Friction
Washer



West Coast

447-0281
1/2" Rubber
Cone
Gasket



936-0065
1/2" Brass
Friction
Washer



609-1165
Brass Coupling
Nut. 1/2" Inlet
Hole

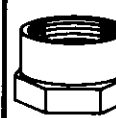

03-09-XQ16 BALLCOCK SERVICE PAK No. 7066

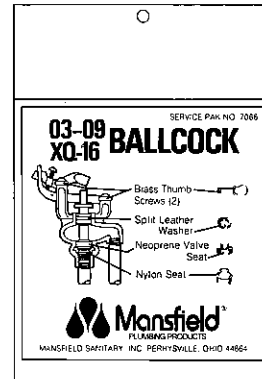

Service Pak includes:

Thumb screw (2) • Nylon seat
Neoprene valve seat • Split washer



Mansfield[®]
PLUMBING PRODUCTS

code approved, anti-siphon 12 ballcock competitive, adjustable

This is Mansfield's economy priced anti-siphon ballcock – low cost, but with no sacrifice in Mansfield design and craftsmanship. The Mansfield 12 offers the lasting reliability of red brass, copper, Celcon* and PVC construction. It operates efficiently – and quietly – at all water pressures. A simple turn of the top-mounted screw adjusts water flow. Its sure seal shut-off means there's no whine, no whistle, no squeal – and no leaking. The Mansfield 12 ballcock is virtually trouble-free (but easy to service if need be). The 12 is definitely the answer when a quality, anti-siphon ballcock (at a competitive price) is what you're after.

Celcon* is the registered trademark of Celanese Corp.

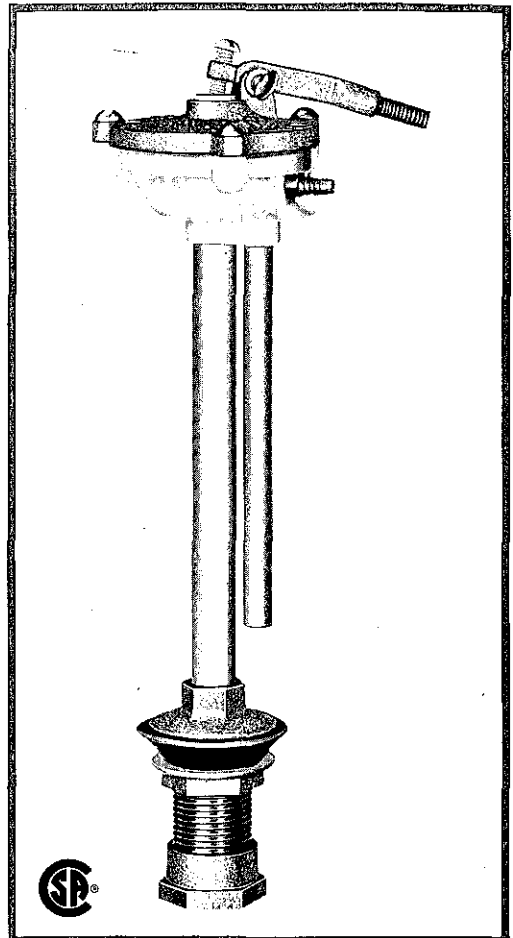

Use these specifications to order

Order No.	Description	Approx. Weight Lbs.
12	Anti-siphon ballcock, complete with 8" brass float rod, 8" vinyl refill tube, brass locknut and coupling nut, coupling nut washer, and shank gasket. Individually boxed. 24 boxes to a carton. Available in 10", 11½", 12½", and 14" lengths.	31

Mansfield 12 Meets Federal Specification WW-P-541.

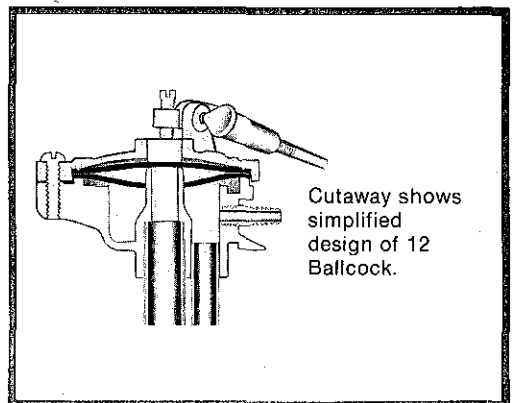

12 ballcock

components and parts list

When ordering, refer to part number and description

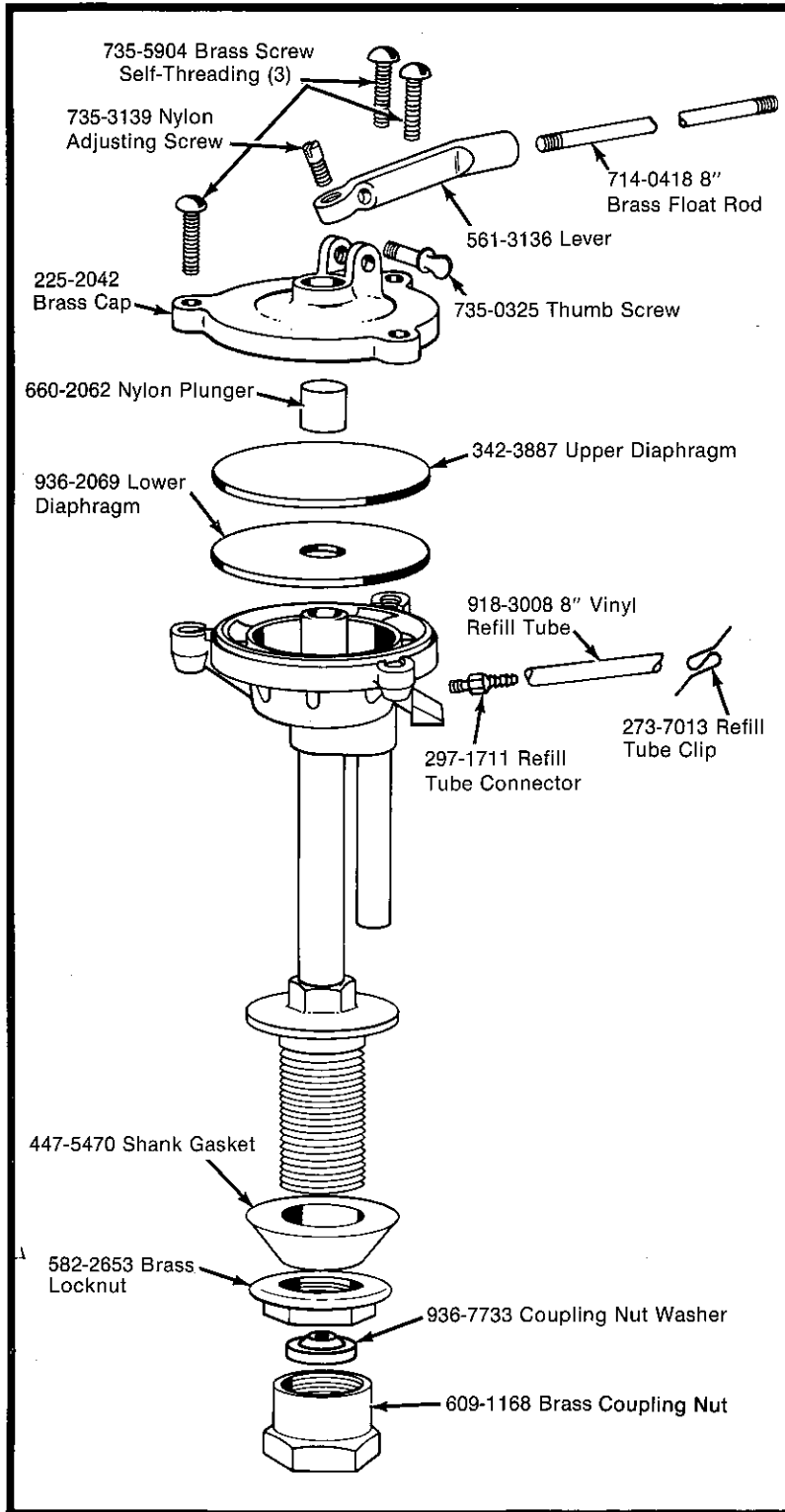

No. 422 Shank Extender

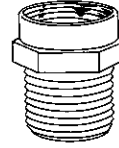

Extends all regular ballcock shanks to 2¾" length. Eliminates need for repair shank ballcocks.

Slip Joint Connection

5/8"

West Coast



447-0371
5/8" Rubber
Cone
Gasket



447-0281
1/2" Rubber
Cone Gasket



936-0370
5/8" Brass
Friction
Washer



936-0065
1/2" Brass
Friction
Washer



609-1165
Brass Coupling
Nut. 1/2" Inlet
Hole

12 BALLCOCK SERVICE PAK No. 5699

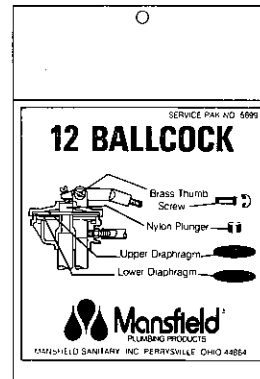

Service Pak includes:

Nylon plunger • Upper diaphragm
Lower diaphragm • Thumb screw

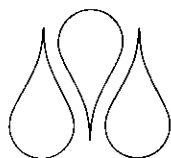

Mansfield[®]
PLUMBING PRODUCTS

extra quiet XQ-16 ballcock quality, all brass construction

The XQ-16 sets new standards of performance – new standards for extra quiet, smooth, trouble-free operation. In its streamlined design, Mansfield has included outstanding performance features. The XQ-16 offers the reliability of cast red brass and seamless copper construction. The compound lever action gives positive opening and closing. No whine, no whistle, no rattle. A longlife nylon valve seat and neoprene washer form a perfect seal against leaks. A positive action plunger with huva-cup seal prevents leaks and squirting. And to adjust the water flow rate, a simple turn of the knurled ring on top of the body is all it takes. The Mansfield XQ-16. All that, and extra quiet, too, regardless of water pressure. Altogether, it's the modern, quality choice.

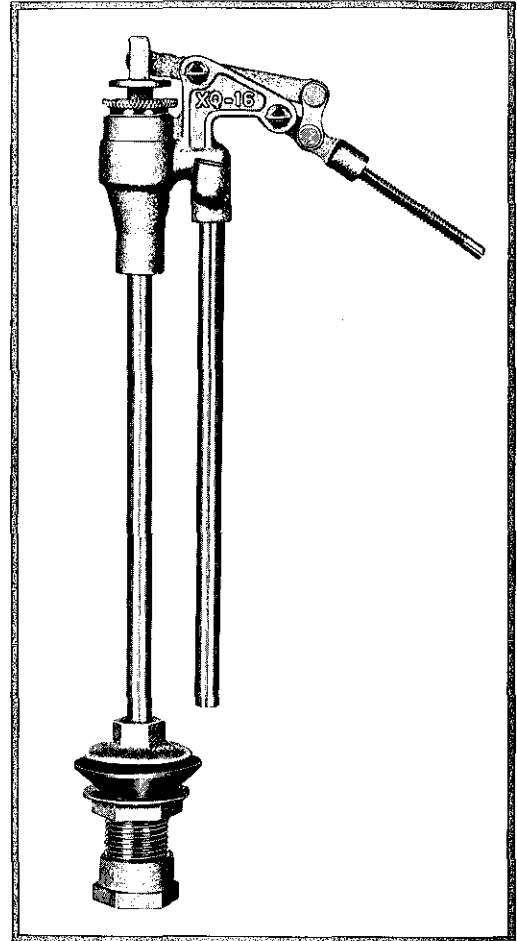

Use these specifications to order

Order No.	Description	Approx. Weight Lbs.
XQ-16	Ballcock complete with 6" brass float rod, 10" vinyl refill tube, brass locknut and coupling nut, coupling nut washer and shank gasket. Individually boxed, 20 boxes to a carton.	30

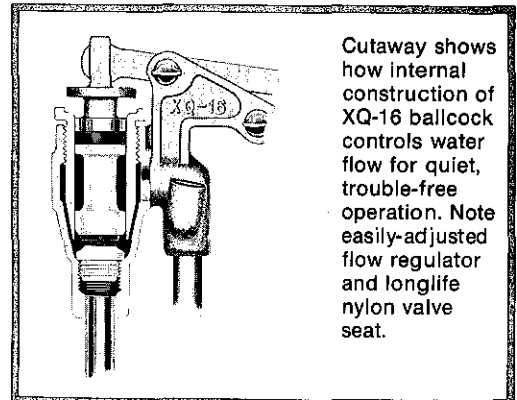

Cutaway shows how internal construction of XQ-16 ballcock controls water flow for quiet, trouble-free operation. Note easily-adjusted flow regulator and longlife nylon valve seat.



XQ-16 ballcock

components and parts list

When ordering, refer to part number and description

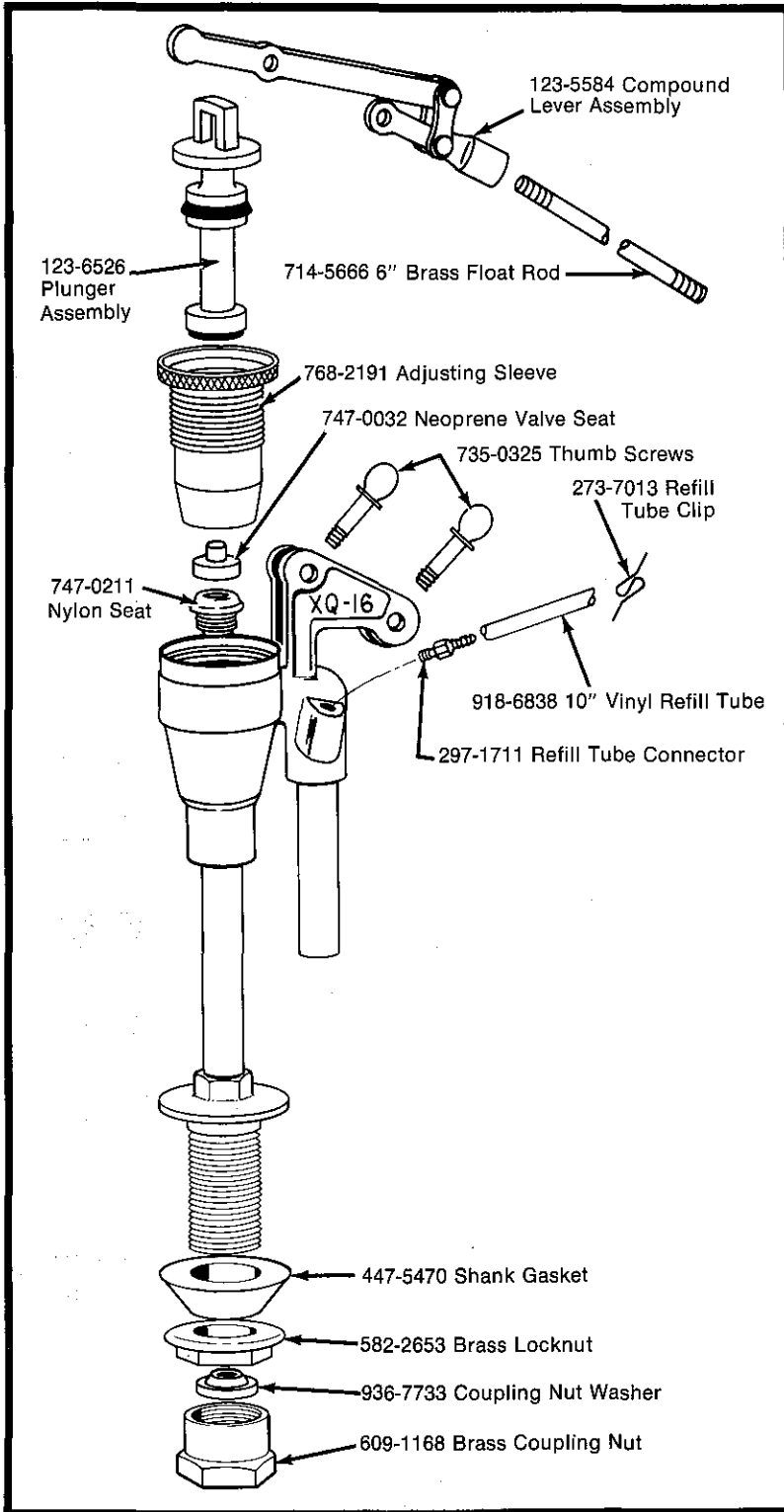

No. 422 Shank Extender

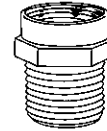

For extending all regular ballcock shanks to 2 $\frac{3}{4}$ " length. Eliminates need for repair shank ballcocks.

Slip Joint Connection

5/8"

West Coast

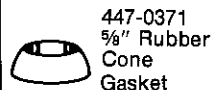

447-0371
5/8" Rubber
Cone
Gasket



447-0281
1/2" Rubber
Cone Gasket



936-0370
5/8" Brass
Friction
Washer



936-0065
1/2" Brass
Friction
Washer

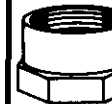

609-1165
Brass Coupling
Nut. 1/2" Inlet
Hole

03-09-XQ-16 BALLCOCK SERVICE PAK NO. 7066

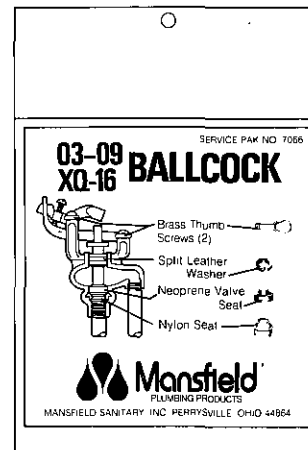

Service Pak includes:

Thumb screw (2) • Nylon seat
Neoprene valve seat • Split washer



Mansfield[®]
PLUMBING PRODUCTS

liquid level control valve

easy to adjust, dependable, versatile

The Mansfield 370 liquid level control valve offers you a dependable, automatic way to maintain a liquid supply at *any* level you set. It's ideal for cooling towers, stock tanks, poultry troughs, oil level control...and many other uses. It features cast brass construction; gives you a choice of 1/2" or 3/4" MSPS inlet and 1/2" FSPS outlet; and can be mounted in either horizontal or vertical position. Using the 6" rod, chain and float ball, the valve opens and closes as needed...with no leak, no chatter. Its ratchet and thumb screw connection make it easy to adjust to exact liquid levels.

Its lever mechanism swivels a full 360°, helping prevent damage in an open tank or trough. A heavy-duty neoprene washer and "O" ring on the plunger prevent leakage, assure positive opening and closing. The plunger is easy to remove...the neoprene washer easy to replace. Each 370 liquid level control valve is individually tested for reliability by Mansfield Sanitary, Inc.

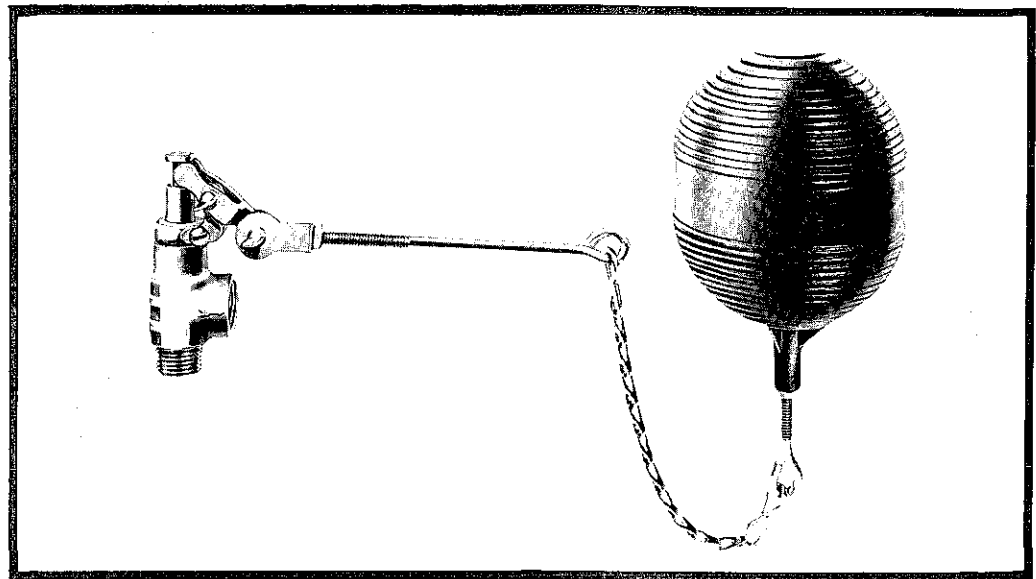

Use these specifications to order

Order No.	Description	Approx. Weight
370 x 1/2	Liquid Level Control Valve with ratchet float arm • 6" rod, chain and float ball • 1/2" MSPS inlet - 1/2" FSPS outlet • Individually boxed, 10 boxes to a carton.	13 lbs. per carton
370L x 1/2	Same as 370 x 1/2 less rod, chain and float. Bulk only.	3/4 lb. each
370 x 3/4	Liquid Level Control Valve with ratchet float arm • 6" rod, chain and float ball • 3/4" MSPS inlet - 1/2" FSPS outlet • Individually boxed, 10 boxes to a carton.	13 lbs. per carton
370L x 3/4	Same as 370 x 3/4 less rod, chain and float. Bulk only.	3/4 lb. each



370 liquid level control valve

components and parts list

When ordering, refer to part number and description

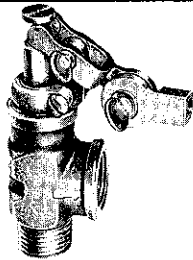
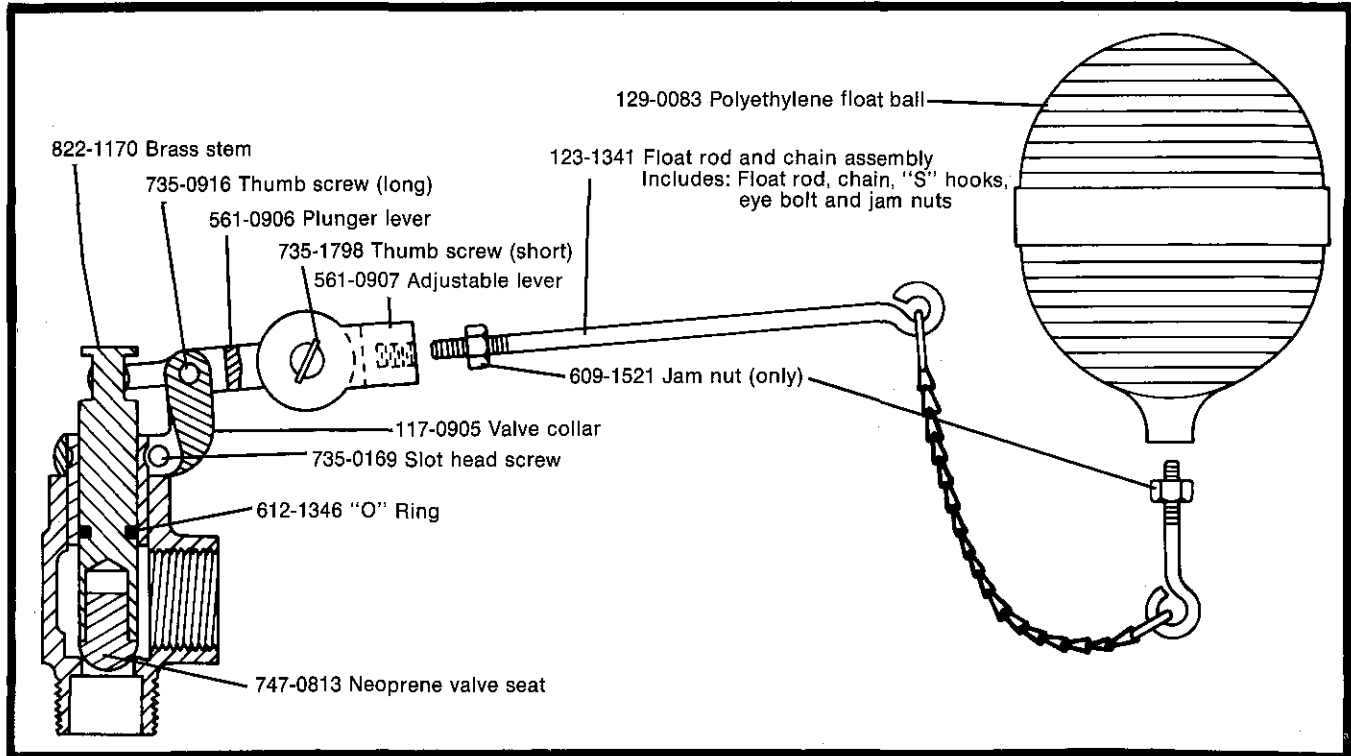

Ratchet and thumb screw connection on actuating arm and float rod holder make it easy to adjust valve to any desired liquid level. Complete lever mechanism can be swiveled 360°, an important feature in preventing damage from livestock nuzzling.



No chatter...replaceable washer
 Lower end of valve plunger is equipped with a heavy-duty, neoprene washer. Entire plunger is readily removable. "O" ring prevents leakage around plunger.

TYPICAL INSTALLATION

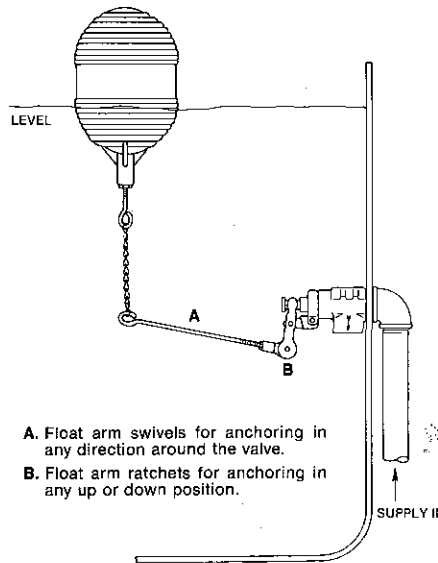

A. Float arm swivels for anchoring in any direction around the valve.
 B. Float arm ratchets for anchoring in any up or down position.

370 LIQUID LEVEL CONTROL VALVE SERVICE PAK No. 7057

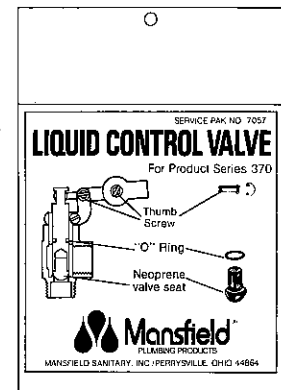

Service Pak includes:
 Thumb screw
 "O" Ring
 Neoprene valve seat

